

ASSEMBLY INSTRUCTION

REEVES

Outdoor Hanging Chair

ITEM CODE:76246

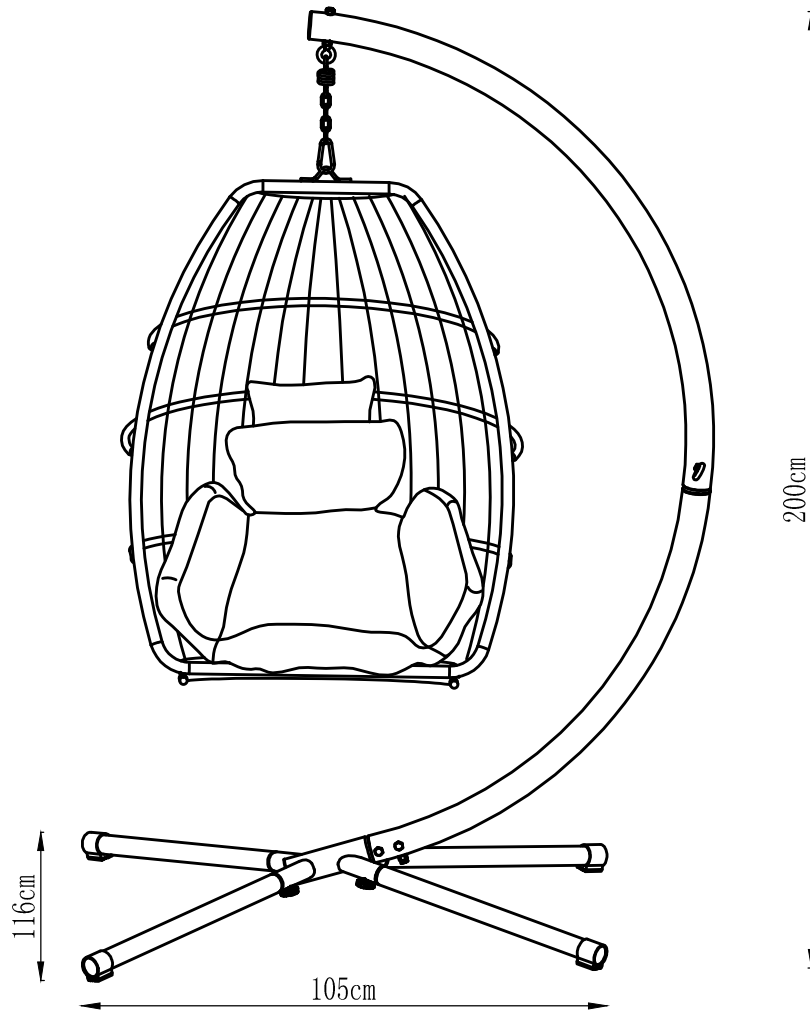

Imported by JWA Furniture Pty Ltd, Qld, Brisbane Australia.
For any assistance with assembly or for missing parts please refer to your receipt

PRE-ASSEMBLY PREPARATION





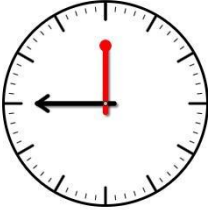
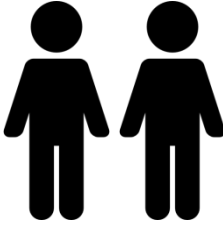



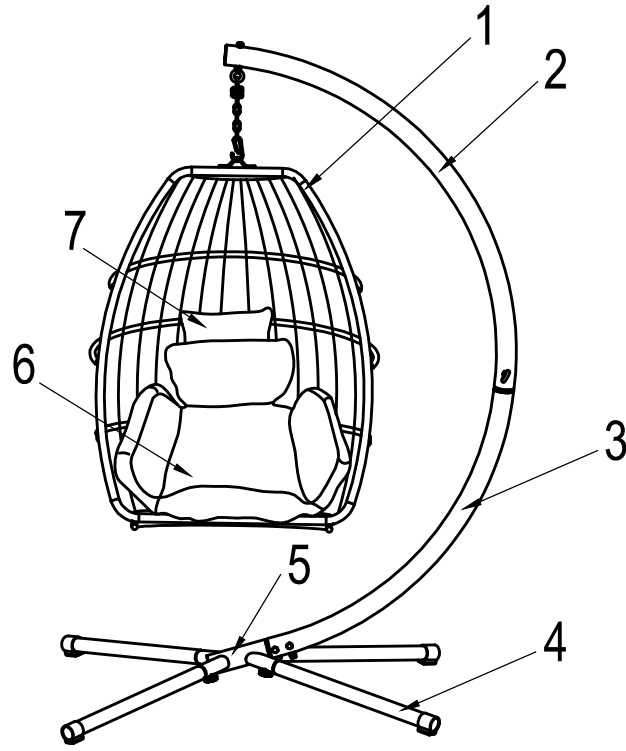



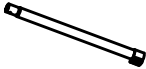



Before you start:

1. Choose a clean, level, spacious assembly area. Avoid hard surfaces that may damage the product
2. Take care when lifting. Product should be assembled as near as possible to the point of use
3. Ensure that you have all required contents for complete assembly
4. Always read the assembly instructions carefully before beginning assembly.
5. Keep all hardware parts and packaging out of reach of small children.
6. Do not over tighten the screws and bolts as this may damage the threads
7. Assembly is to be carried out by a competent adult(s) ONLY
8. During assembly, children should be kept away from the product due to possible risk to injury.
9. Do not use this item if any components are missing or damaged.
10. Please keep the instructions for future reference.

	
Allow 60 min	For 2 person





PARTS LIST

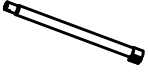

1. HANGING EGG  1PC		2. SUPPORT BAR 1  1PC		3. SUPPORT BAR 2  1PC	
4. Leg  4PCS		5. Base Connector  1PC		6. CUSHION  1PC	
7. BOLSTER  1PC					
A. Safety pothook  1PC	B. Chain  1PC	C. Spring hook  1PC	D. Bolt  M10*18 5PCS	E. Bolt  M8 1PC	
F. Nut  1PC	G. Wrench  1PC	H. Knob  4PCS	I. Foot pad  4PCS	J. rope  1PC	

Step 1:

ITEMS REQUIRED

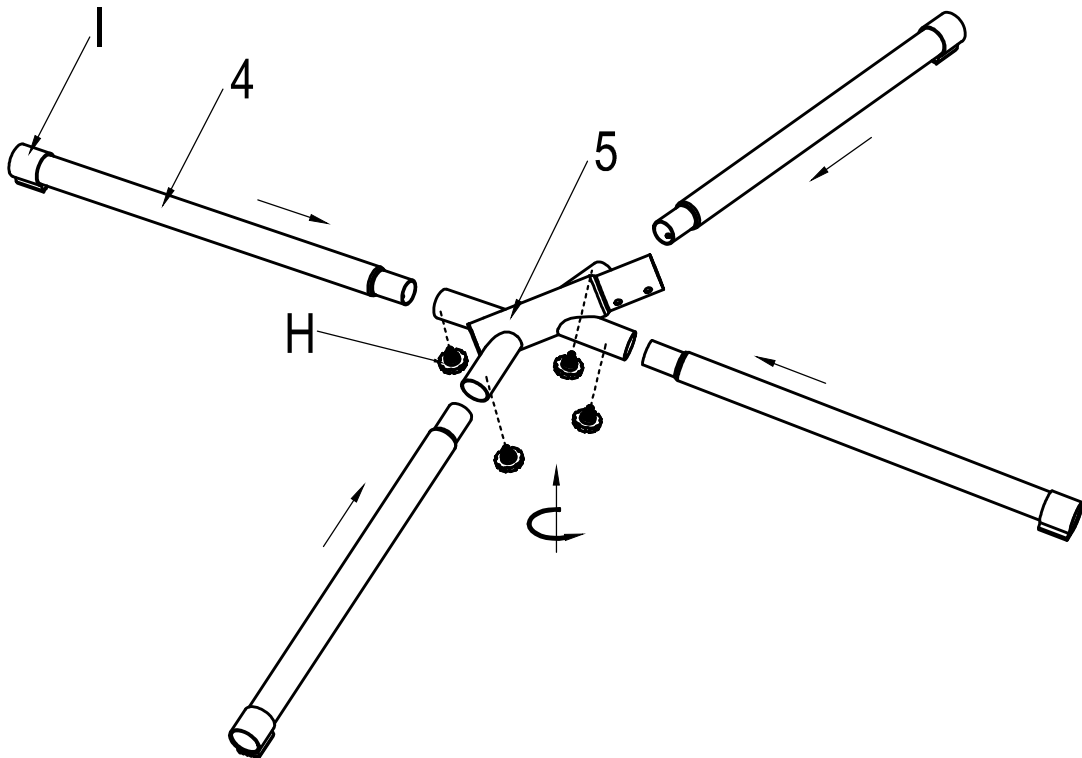

4. Leg  4PCS	5. Base Connector  1PC	H. Knob  4PCS	I. Foot pad  4PCS
---	---	--	--

- Insert legs (4) to base connector (5) to ensure all legs secured in place.
- Screw the knob (H) into the base connector (5).

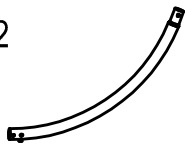

Step 2:

ITEMS REQUIRED

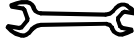

3. Support bar 2  1PC	D. Bolt  M10*18 5PCS	G. Wrench  1PC
--	---	---

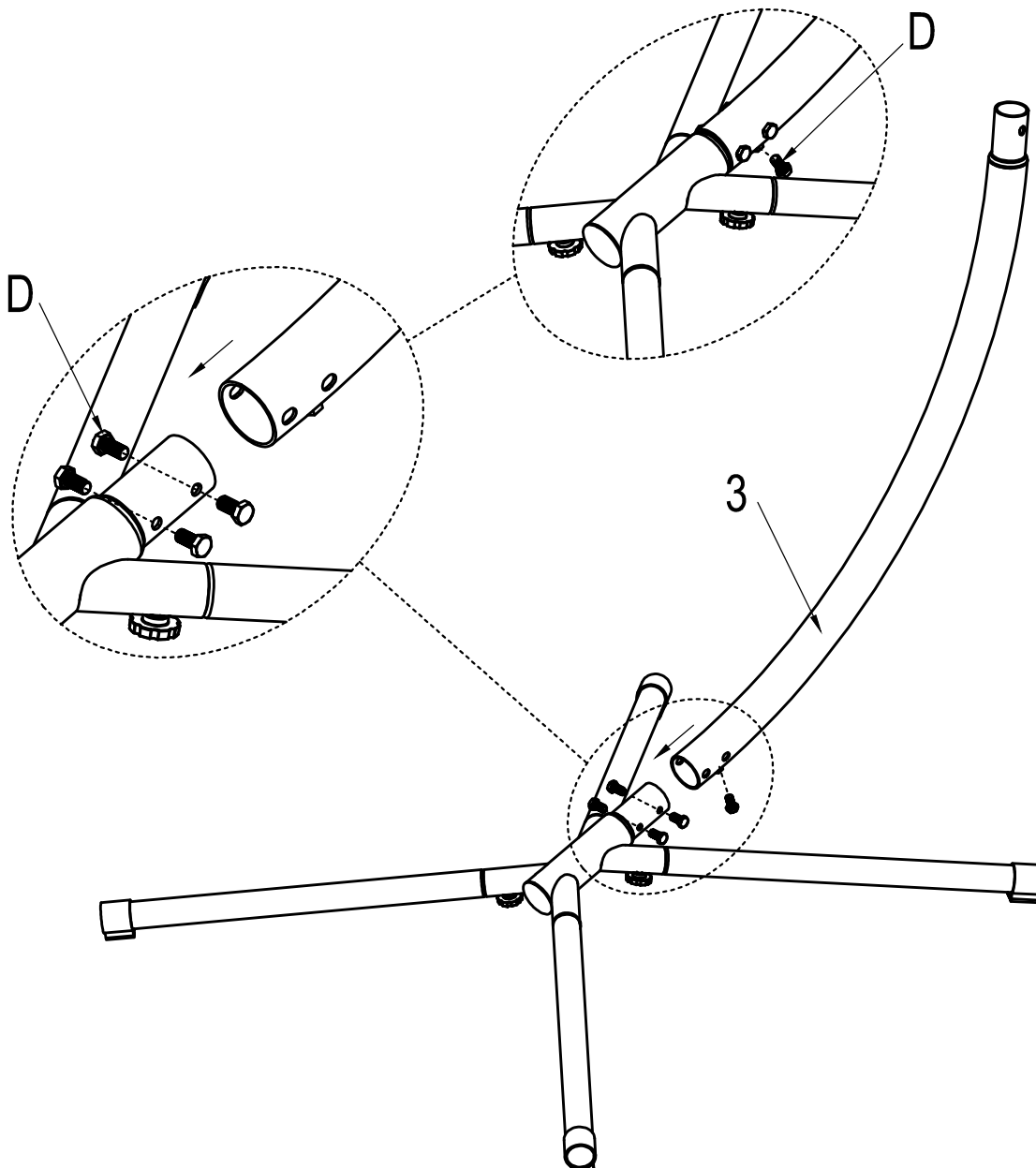
- Attach support bar (3) to the base connector (5), then align the screw holes and lock with bolt (D).
- Insert all bolts before fully tightening .
- Tighten with wrench (G).



Step 3:

ITEMS REQUIRED

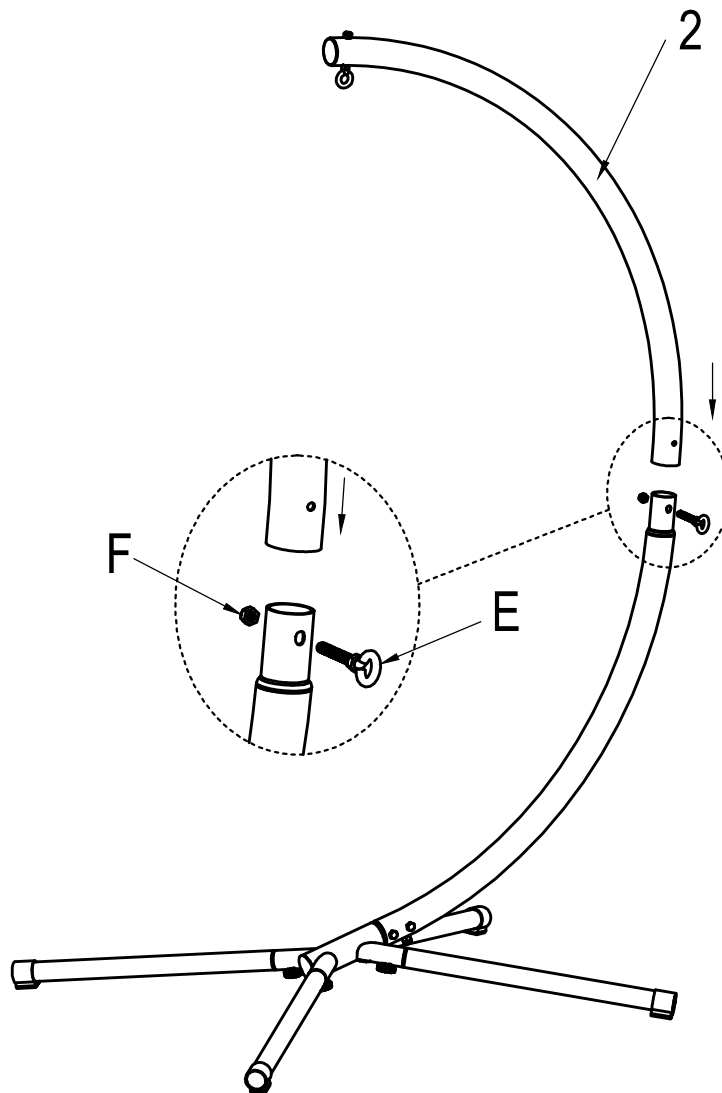

2. Support bar 1  1PC	E. Bolt  1PC	F. Nut  1PC
---	--	---

- connect support bar (2) and (3) together by using bolt (E).



Step 4:

ITEMS REQUIRED

C. Spring hook  1PC	B. Chain  1PC	A. Safety pothook  1PC
--	--	--

- connect the spring hook (C), chain (B), safety pothook (A) in a string, then attach to the bolt that already fixed on the support bar (2). ■

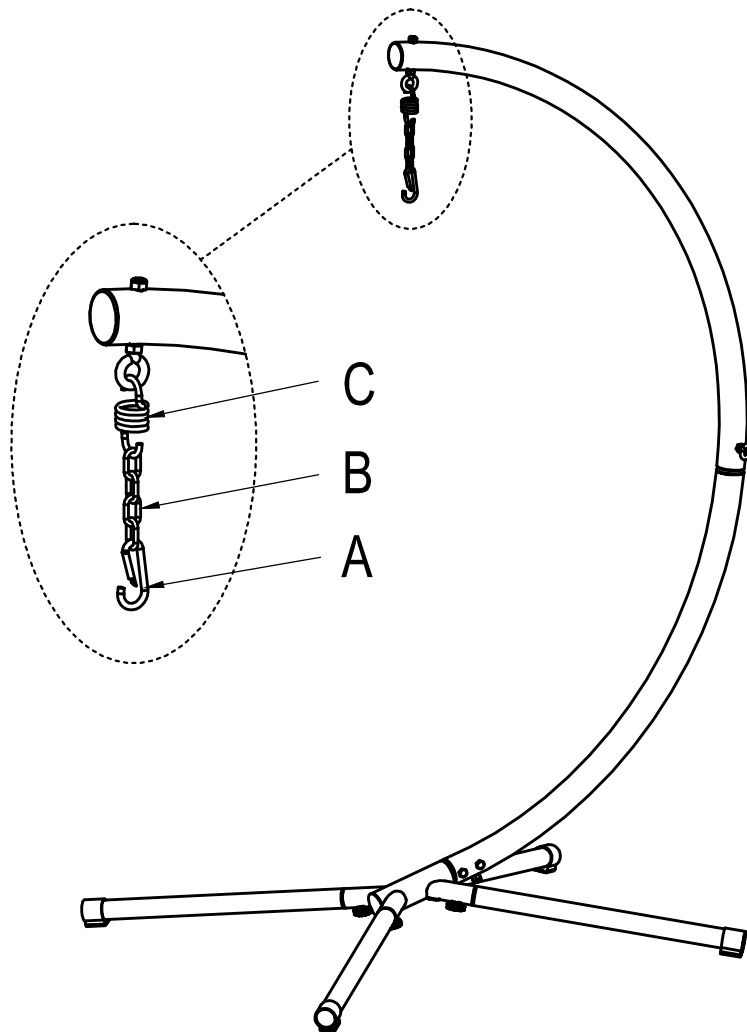

Step 5

ITEMS REQUIRED

1. HANGING EGG

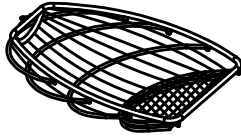

1PC

- Unfold hanging egg (1).

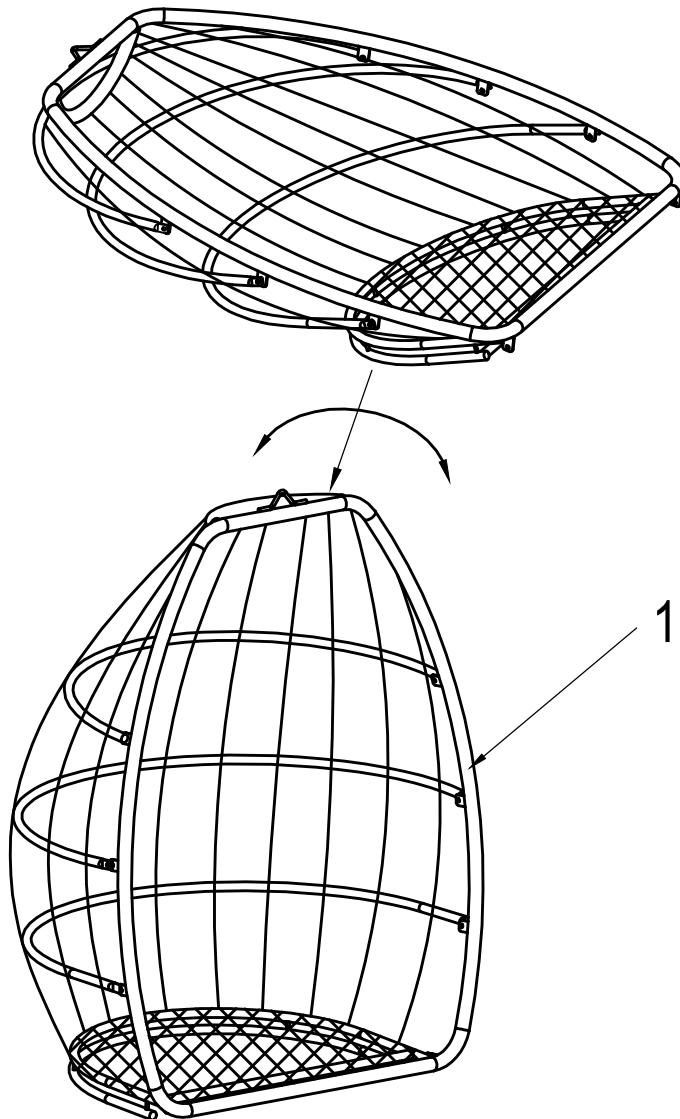

Step 6

ITEMS REQUIRED

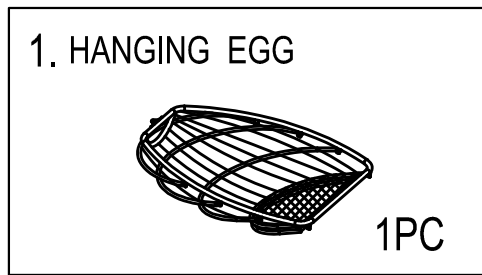

- Attach hanging egg (1) to the safety pothook (A).

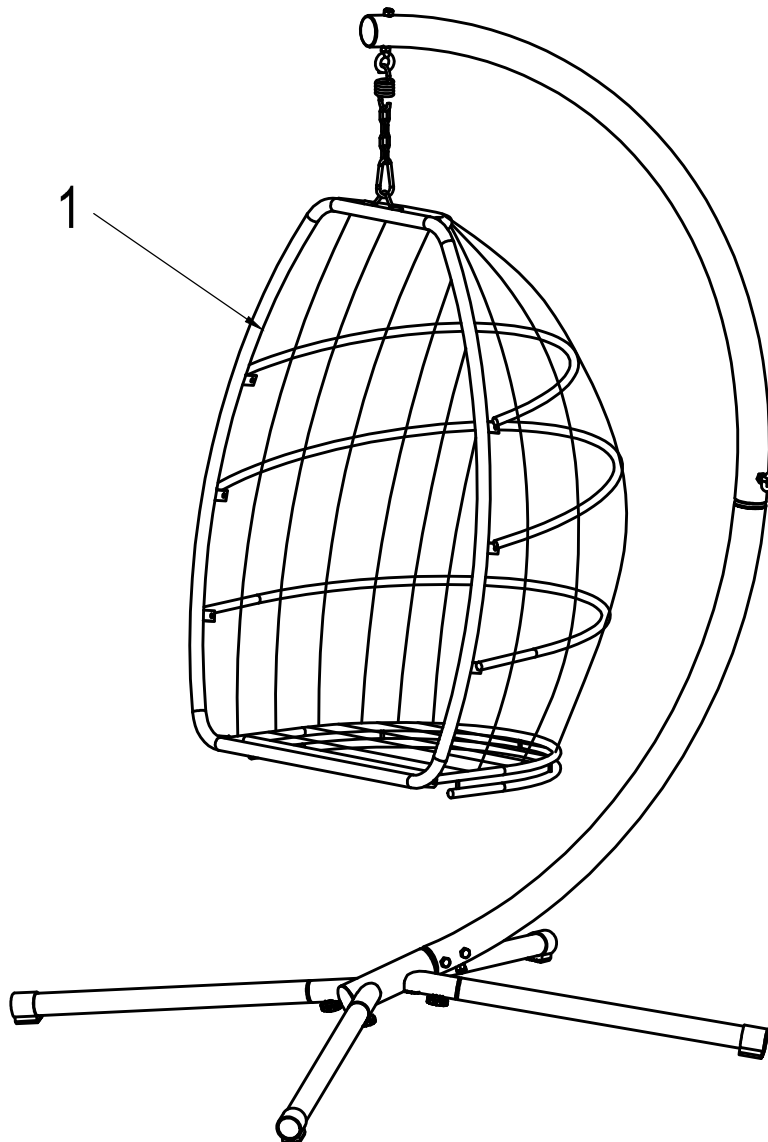

Step 7

ITEMS REQUIRED

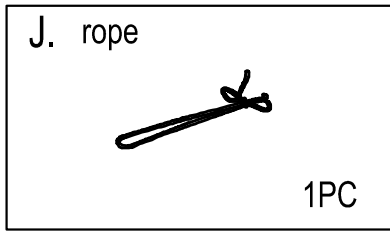

- Tie hanging egg to support pole by using rope (J).

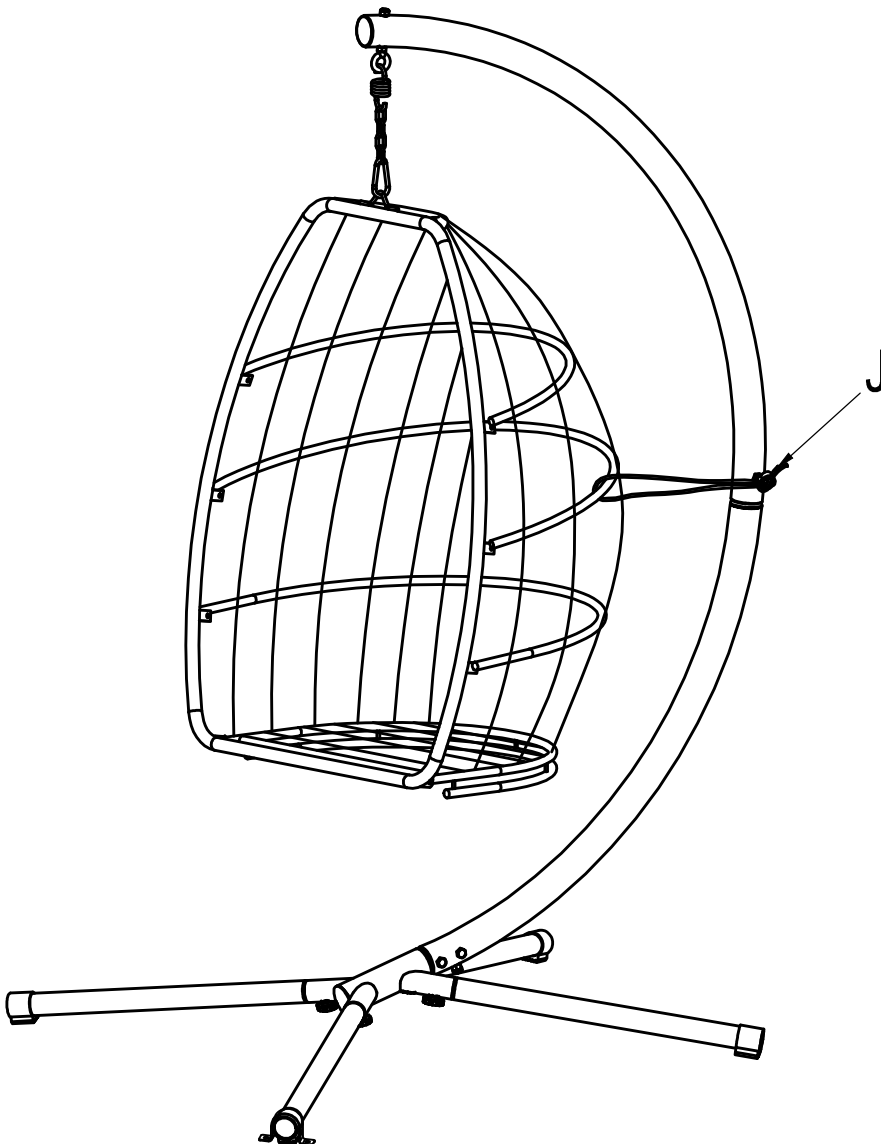

ASSEMBLY IS COMPLETE

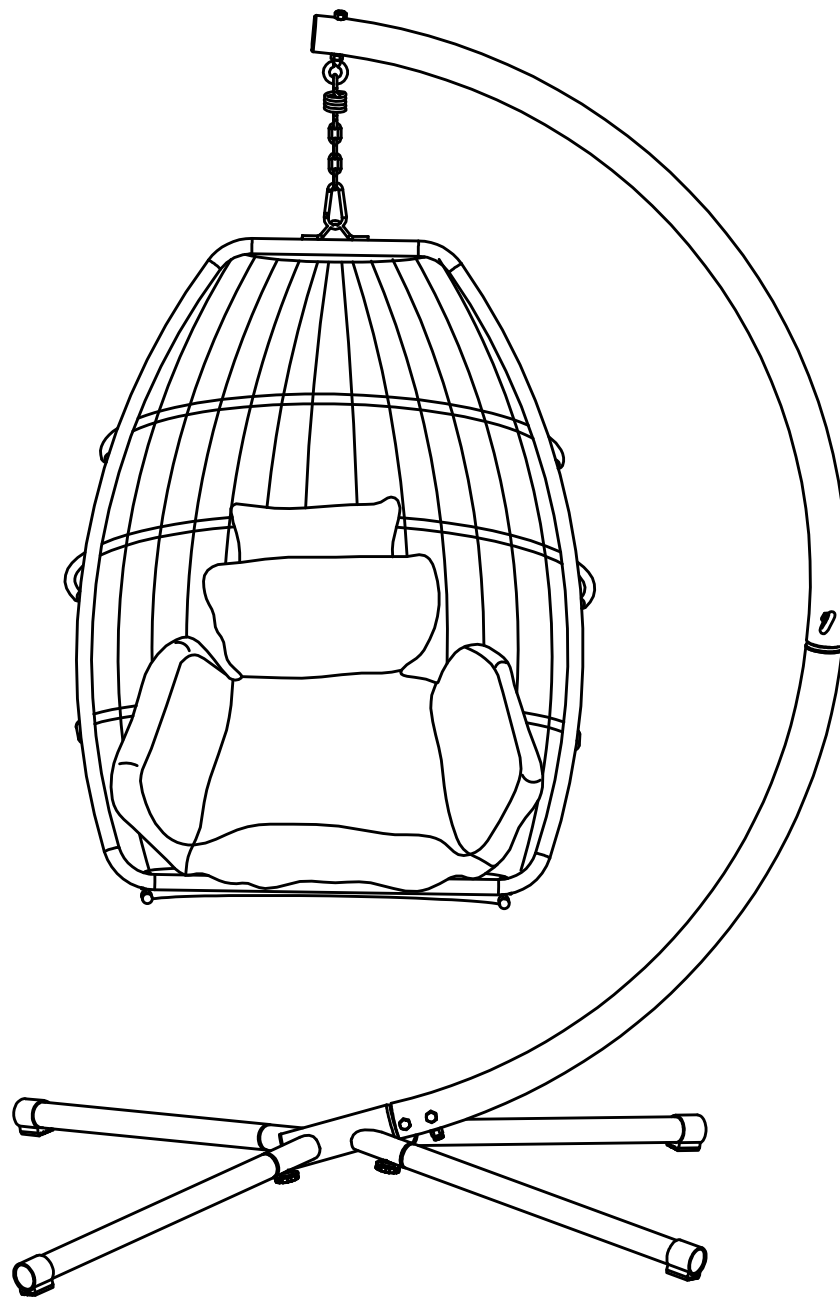

PRODUCT CARE

Cushions

- ☒ Direct exposure to the Sun's harmful UV rays is likely to cause rapid colour fading to fabrics. For best results we recommend avoiding exposure to direct sunlight
- ☒ To ensure product longevity it is recommended outdoor products are not left permanently exposed to the elements
- ☒ Spot clean using mild detergent and damp cloth. Dry flat in shade
- ☒ Do not unzip
- ☒ Do not put in washing machine
- ☒ Do not tumble dry
- ☒ Do not bleach
- ☒ Do not dry clean
- ☒ Cool iron only

Metal

- ☒ Item is designed for use outdoors. However we do not recommend leaving this product outside when not in use. To preserve the life of this item, avoid prolonged exposure to the elements & store inside/under cover or use an outdoor cover.
- ☒ DO NOT allow the furniture to be left in the rain or left wet for extended periods of time.
- ☒ Wipe furniture Dry immediately after it becoming wet.
- ☒ DO NOT clean your furniture down with any harsh solvents, abrasives or chemicals.
- ☒ To remove dirt and grime, simply rinse with fresh water or periodically clean using a sponge and mild detergent solution as required